

OptiMOS[®] 2 Power-Transistor

Features

- Ideal for high-frequency dc/dc converters
- Qualified according to JEDEC¹⁾ for target applications
- N-channel - Logic level
- Excellent gate charge x $R_{DS(on)}$ product (FOM)
- Very low on-resistance $R_{DS(on)}$
- Superior thermal resistance
- 175 °C operating temperature
- dv/dt rated

Product Summary

V_{DS}	25	V
$R_{DS(on),max}$ (SMD version)	2.7	m Ω
I_D	80	A

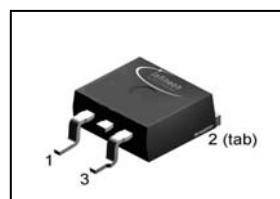
P-TO263-3-2

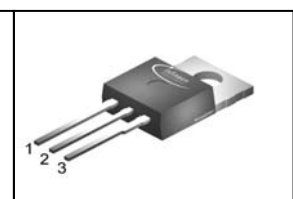
P-TO262-3-1

P-TO220-3-1

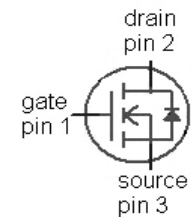
Type	Package	Ordering Code	Marking
IPB03N03LA	P-TO263-3-2	Q67042-S4178	03N03LA
IPI03N03LA	P-TO262-3-1	Q67042-S4180	03N03LA
IPP03N03LA	P-TO220-3-1	Q67042-S4179	03N03LA



Maximum ratings, at $T_j=25\text{ °C}$, unless otherwise specified

Parameter	Symbol	Conditions	Value	Unit
Continuous drain current	I_D	$T_C=25\text{ °C}^{2)}$	80	A
		$T_C=100\text{ °C}$	80	
Pulsed drain current	$I_{D,pulse}$	$T_C=25\text{ °C}^{3)}$	385	
Avalanche energy, single pulse	E_{AS}	$I_D=80\text{ A}, R_{GS}=25\ \Omega$	960	mJ
Reverse diode dv/dt	dv/dt	$I_D=80\text{ A}, V_{DS}=20\text{ V},$ $di/dt=200\text{ A}/\mu\text{s},$ $T_{j,max}=175\text{ °C}$	6	kV/ μs
Gate source voltage ⁴⁾	V_{GS}		± 20	V
Power dissipation	P_{tot}	$T_C=25\text{ °C}$	150	W
Operating and storage temperature	T_j, T_{stg}		-55 ... 175	°C
IEC climatic category; DIN IEC 68-1			55/175/56	

¹⁾ J-STD20 and JESD22

Parameter	Symbol	Conditions	Values			Unit
			min.	typ.	max.	

Thermal characteristics

Thermal resistance, junction - case	R_{thJC}		-	-	1	K/W
SMD version, device on PCB	R_{thJA}	minimal footprint	-	-	62	
		6 cm ² cooling area ⁵⁾	-	-	40	

Electrical characteristics, at $T_j=25\text{ }^\circ\text{C}$, unless otherwise specified
Static characteristics

Drain-source breakdown voltage	$V_{(BR)DSS}$	$V_{GS}=0\text{ V}, I_D=1\text{ mA}$	25	-	-	V
Gate threshold voltage	$V_{GS(th)}$	$V_{DS}=V_{GS}, I_D=100\text{ }\mu\text{A}$	1.2	1.6	2	
Zero gate voltage drain current	I_{DSS}	$V_{DS}=25\text{ V}, V_{GS}=0\text{ V}, T_j=25\text{ }^\circ\text{C}$	-	0.1	1	μA
		$V_{DS}=25\text{ V}, V_{GS}=0\text{ V}, T_j=125\text{ }^\circ\text{C}$	-	10	100	
Gate-source leakage current	I_{GSS}	$V_{GS}=20\text{ V}, V_{DS}=0\text{ V}$	-	10	100	nA
Drain-source on-state resistance	$R_{DS(on)}$	$V_{GS}=4.5\text{ V}, I_D=55\text{ A}$	-	3.6	4.4	m Ω
		$V_{GS}=4.5\text{ V}, I_D=55\text{ A},$ SMD version	-	3.3	4.1	
		$V_{GS}=10\text{ V}, I_D=55\text{ A}$	-	2.5	3.0	
		$V_{GS}=10\text{ V}, I_D=55\text{ A},$ SMD version	-	2.2	2.7	
Gate resistance	R_G		-	0.9	-	Ω
Transconductance	g_{fs}	$ V_{DS} >2 I_D R_{DS(on)max},$ $I_D=55\text{ A}$	56	112	-	S

²⁾ Current is limited by bondwire; with an $R_{thJC}=1\text{ K/W}$ the chip is able to carry 175 A.

³⁾ See figure 3

⁴⁾ $T_{j,max}=150\text{ }^\circ\text{C}$ and duty cycle $D<0.25$ for $V_{GS}<-5\text{ V}$

⁵⁾ Device on 40 mm x 40 mm x 1.5 mm epoxy PCB FR4 with 6 cm² (one layer, 70 μm thick) copper area for drain connection. PCB is vertical in still air.

Parameter	Symbol	Conditions	Values			Unit
			min.	typ.	max.	

Dynamic characteristics

Input capacitance	C_{iss}	$V_{GS}=0\text{ V}, V_{DS}=15\text{ V}, f=1\text{ MHz}$	-	5283	7027	pF
Output capacitance	C_{oss}		-	2231	2967	
Reverse transfer capacitance	C_{rss}		-	304	457	
Turn-on delay time	$t_{d(on)}$	$V_{DD}=15\text{ V}, V_{GS}=10\text{ V}, I_D=20\text{ A}, R_G=2.7\ \Omega$	-	18	26	ns
Rise time	t_r		-	8.5	13	
Turn-off delay time	$t_{d(off)}$		-	45	68	
Fall time	t_f		-	7.5	11	

Gate Charge Characteristics⁶⁾

Gate to source charge	Q_{gs}	$V_{DD}=15\text{ V}, I_D=40\text{ A}, V_{GS}=0\text{ to }5\text{ V}$	-	16	21	nC
Gate charge at threshold	$Q_{g(th)}$		-	8.5	11.2	
Gate to drain charge	Q_{gd}		-	12	18	
Switching charge	Q_{sw}		-	20	28	
Gate charge total	Q_g		-	43	57	
Gate plateau voltage	$V_{plateau}$		-	3.1	-	
Gate charge total, sync. FET	$Q_{g(sync)}$	$V_{DS}=0.1\text{ V}, V_{GS}=0\text{ to }5\text{ V}$	-	37	49	nC
Output charge	Q_{oss}	$V_{DD}=15\text{ V}, V_{GS}=0\text{ V}$	-	48	64	

Reverse Diode

Diode continuous forward current	I_S	$T_C=25\text{ }^\circ\text{C}$	-	-	80	A
Diode pulse current	$I_{S,pulse}$		-	-	385	
Diode forward voltage	V_{SD}	$V_{GS}=0\text{ V}, I_F=80\text{ A}, T_J=25\text{ }^\circ\text{C}$	-	0.96	1.2	V
Reverse recovery charge	Q_{rr}	$V_R=15\text{ V}, I_F=I_S, di_F/dt=400\text{ A}/\mu\text{s}$	-	-	20	nC

⁶⁾ See figure 16 for gate charge parameter definition

1 Power dissipation

$P_{tot}=f(T_C)$

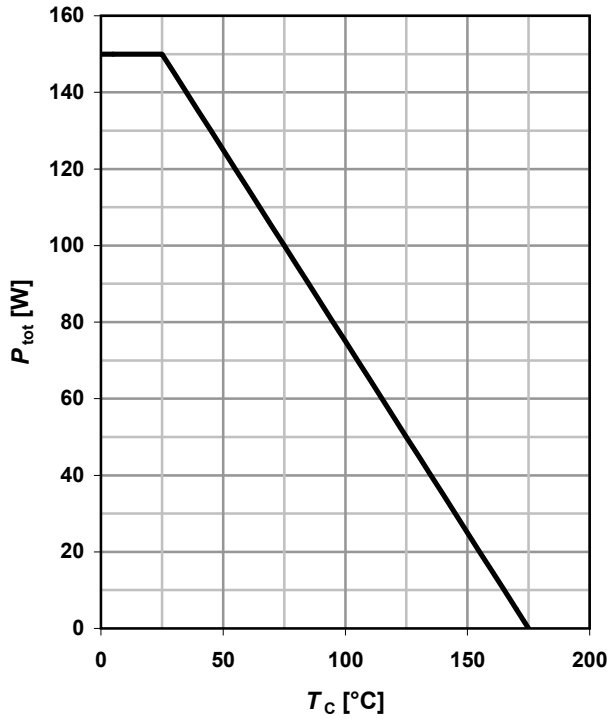

2 Drain current

$I_D=f(T_C); V_{GS} \geq 10\text{ V}$

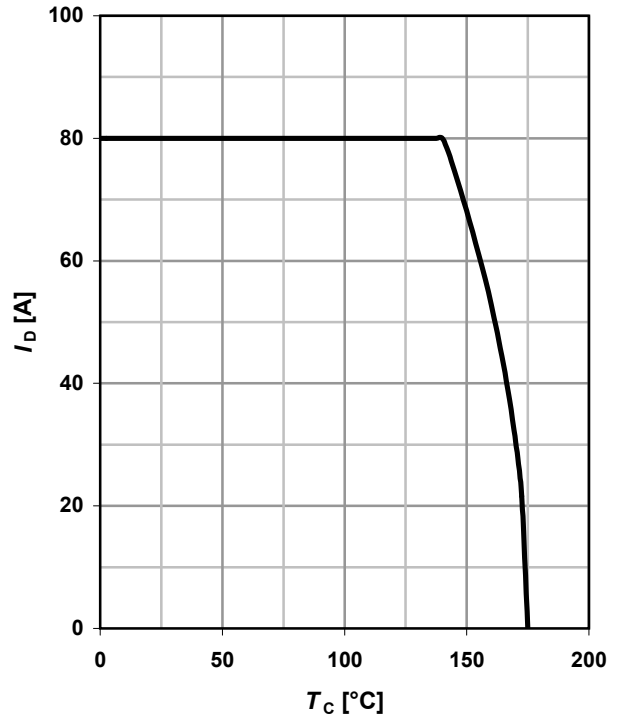

3 Safe operation area

$I_D=f(V_{DS}); T_C=25\text{ }^\circ\text{C}; D=0$

parameter: t_p

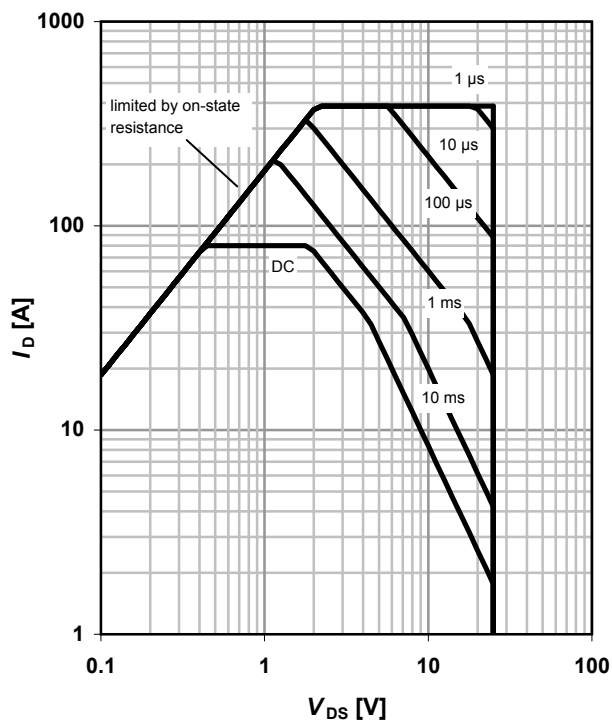

4 Max. transient thermal impedance

$Z_{thJC}=f(t_p)$

parameter: $D=t_p/T$

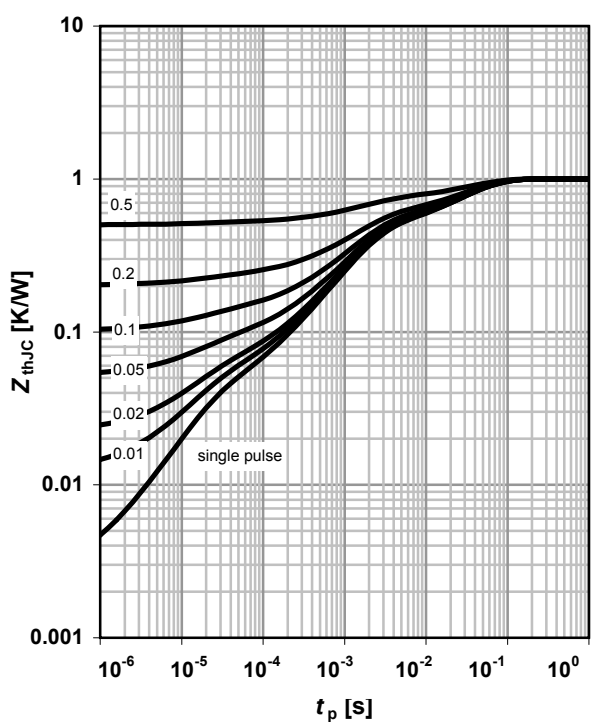

5 Typ. output characteristics

$I_D = f(V_{DS}); T_j = 25\text{ }^\circ\text{C}$

parameter: V_{GS}

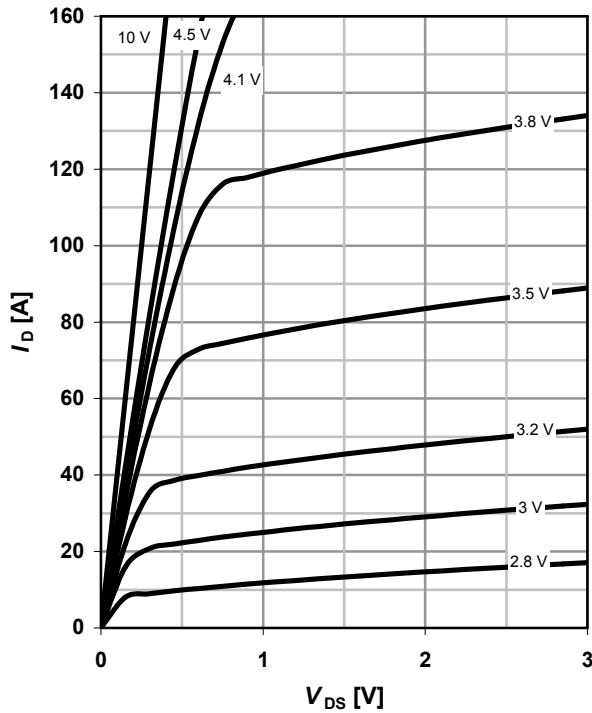

6 Typ. drain-source on resistance

$R_{DS(on)} = f(I_D); T_j = 25\text{ }^\circ\text{C}$

parameter: V_{GS}

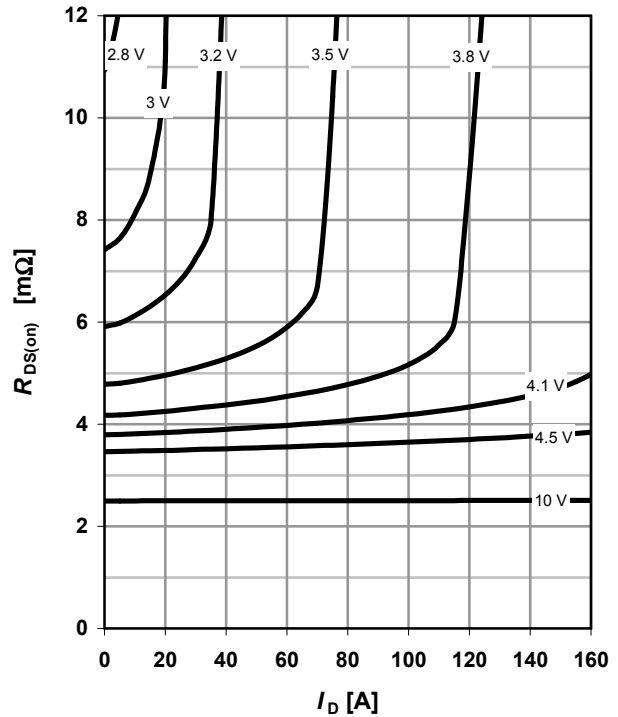

7 Typ. transfer characteristics

$I_D = f(V_{GS}); |V_{DS}| > 2|I_D|R_{DS(on)max}$

parameter: T_j

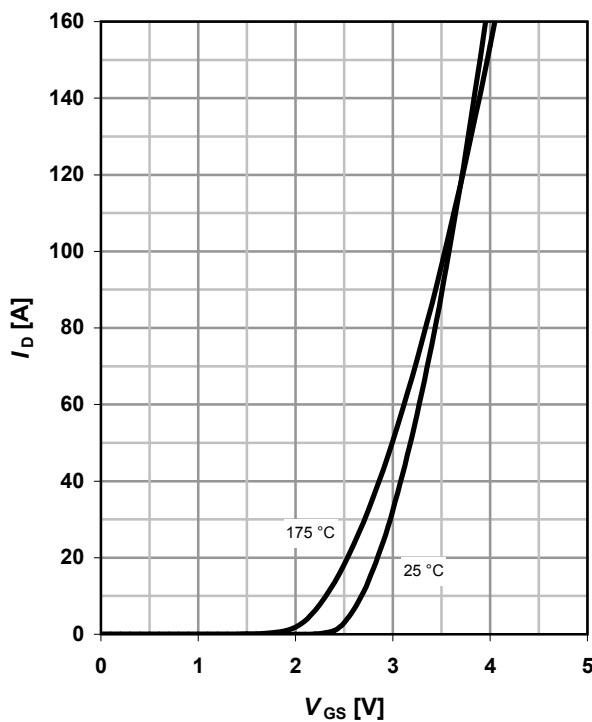

8 Typ. forward transconductance

$g_{fs} = f(I_D); T_j = 25\text{ }^\circ\text{C}$

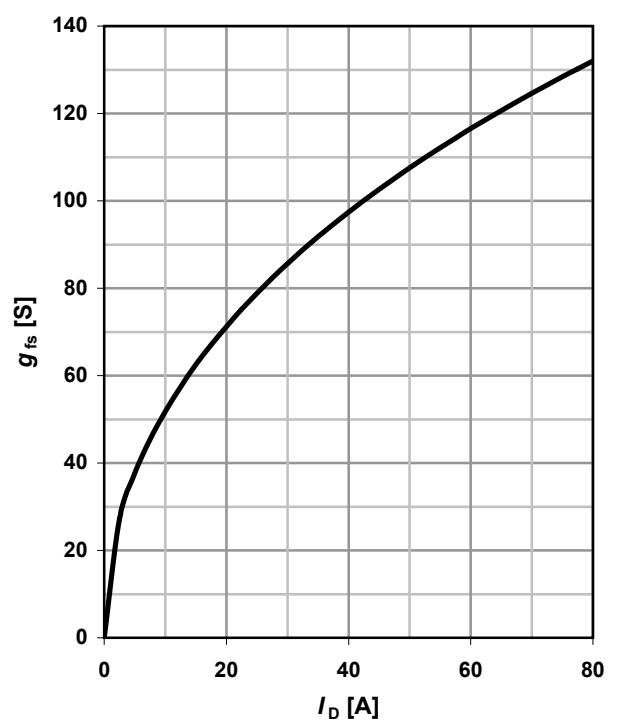

9 Drain-source on-state resistance

$R_{DS(on)} = f(T_j); I_D = 55 \text{ A}; V_{GS} = 10 \text{ V}$

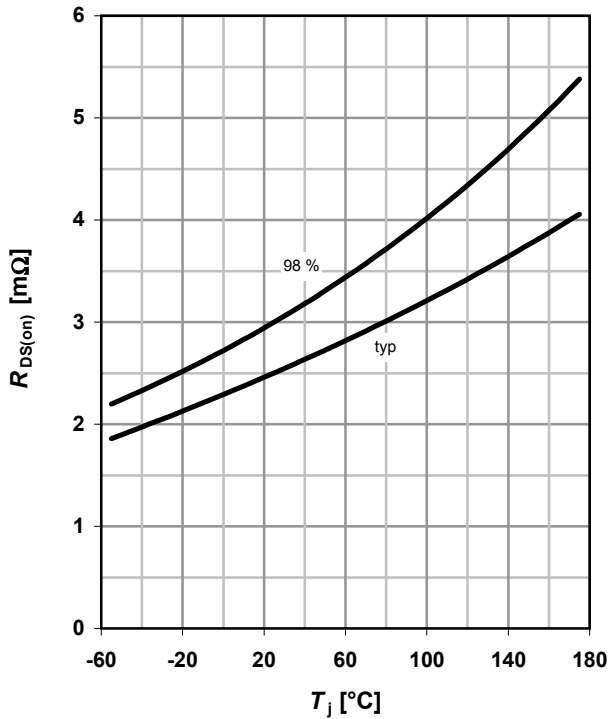

10 Typ. gate threshold voltage

$V_{GS(th)} = f(T_j); V_{GS} = V_{DS}$

parameter: I_D

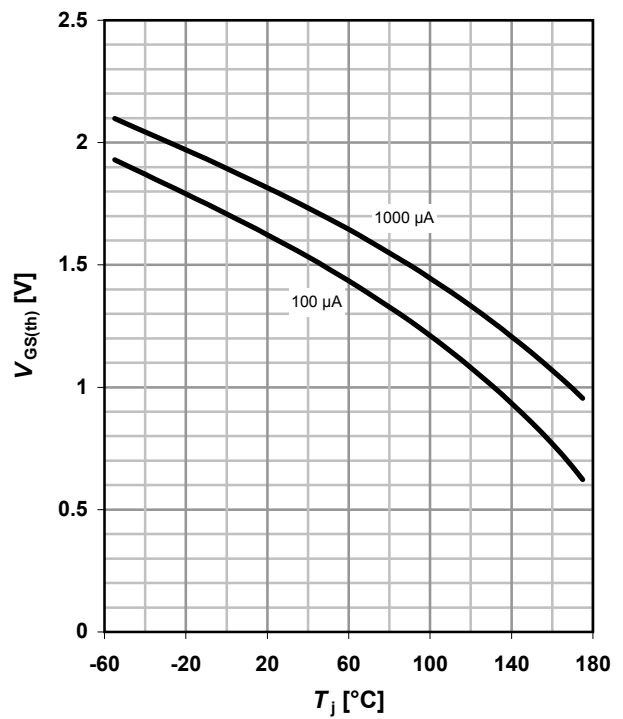

11 Typ. Capacitances

$C = f(V_{DS}); V_{GS} = 0 \text{ V}; f = 1 \text{ MHz}$

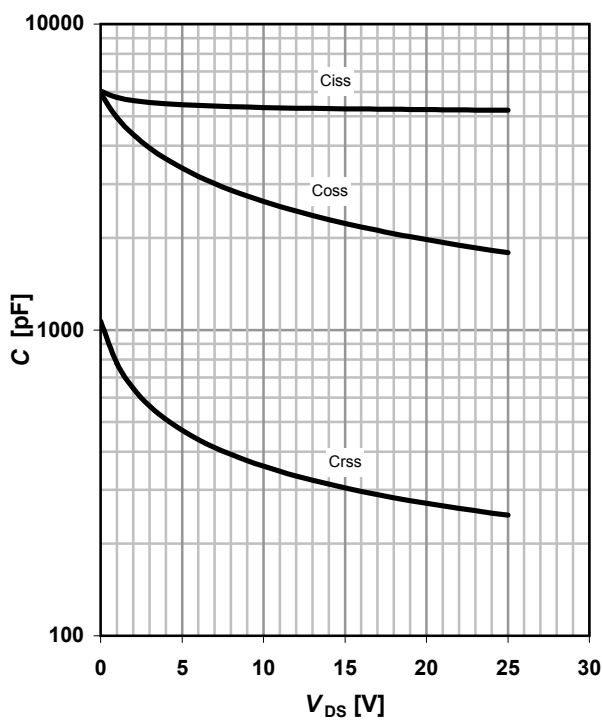

12 Forward characteristics of reverse diode

$I_F = f(V_{SD})$

parameter: T_j

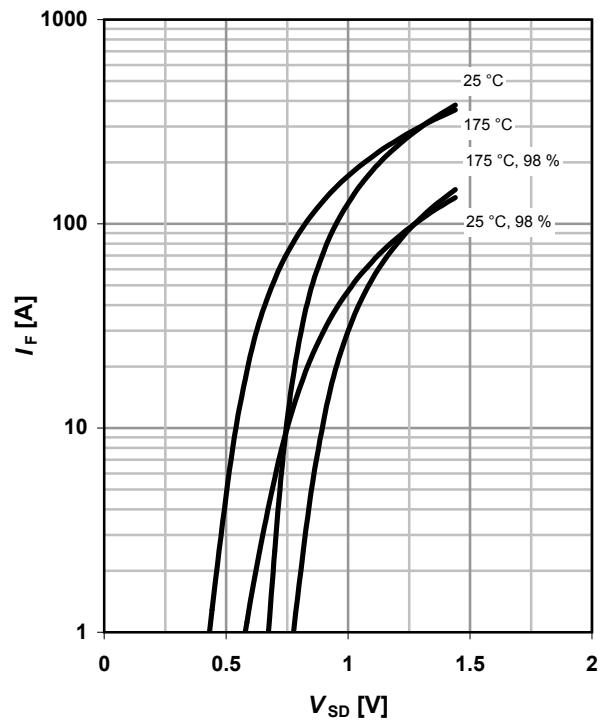

13 Avalanche characteristics

$I_{AS}=f(t_{AV}); R_{GS}=25 \Omega$

parameter: $T_{j(start)}$

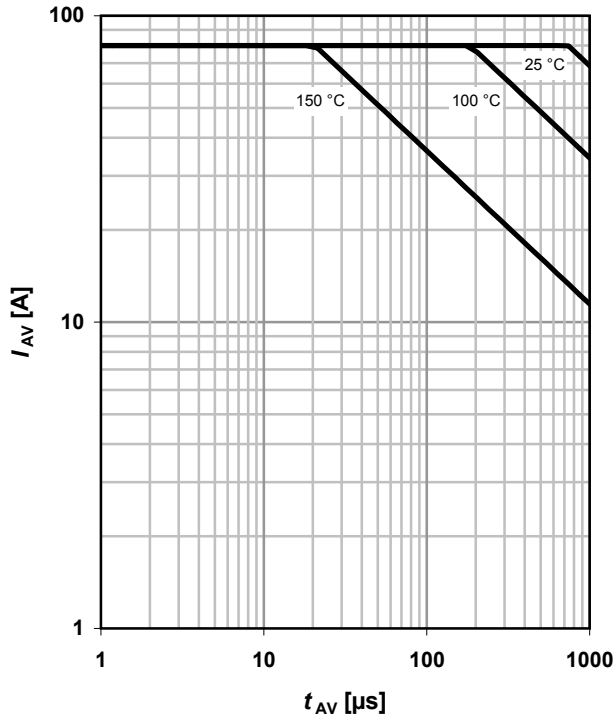

14 Typ. gate charge

$V_{GS}=f(Q_{gate}); I_D=40 \text{ A pulsed}$

parameter: V_{DD}

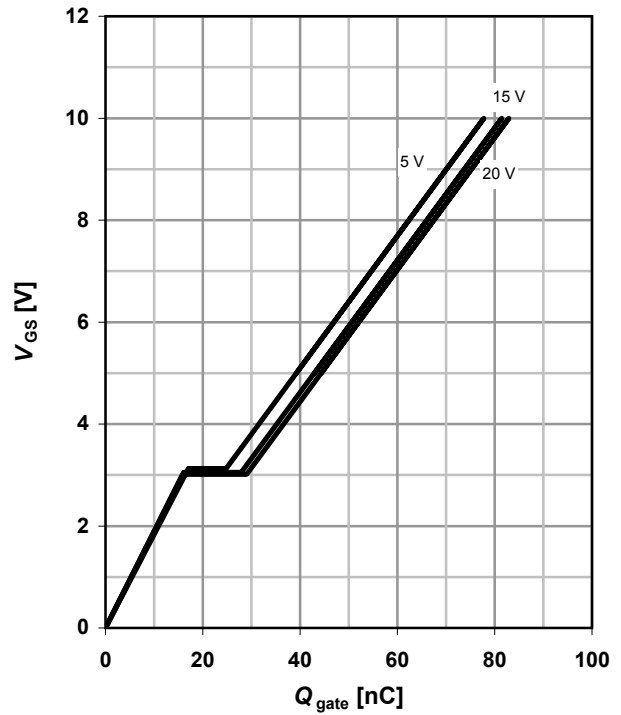

15 Drain-source breakdown voltage

$V_{BR(DSS)}=f(T_j); I_D=1 \text{ mA}$

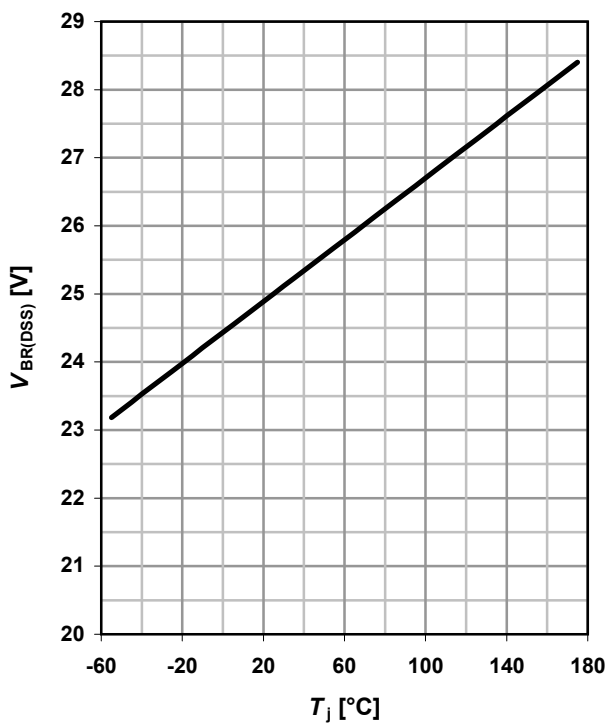

16 Gate charge waveforms

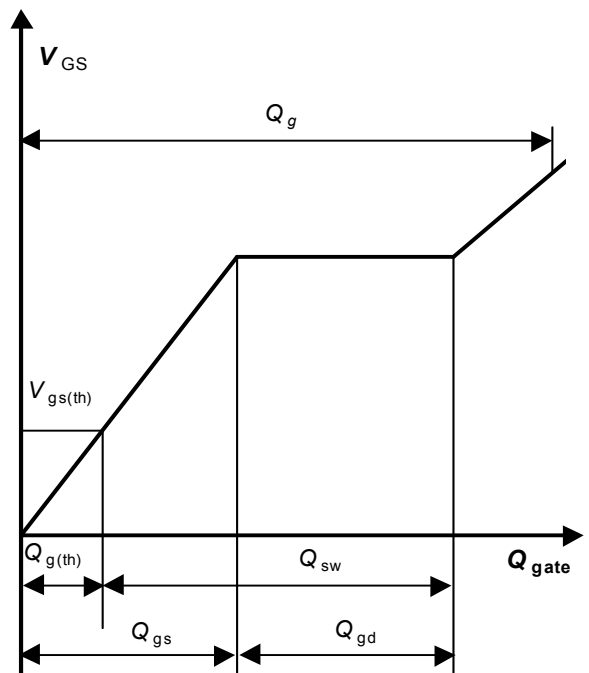

Package Outline

P-TO263-3-2: Outline

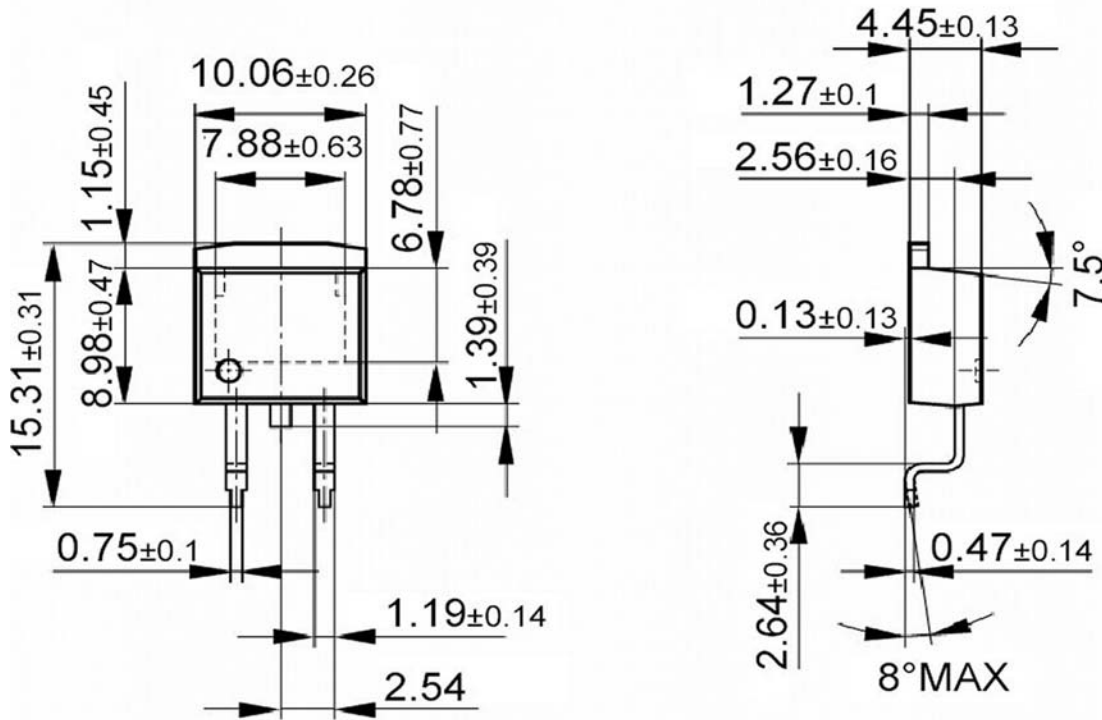

Footprint

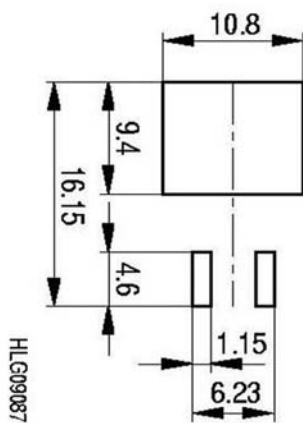

Packaging

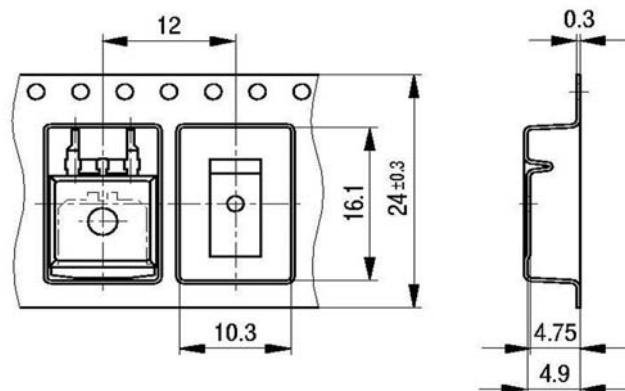

Dimensions in mm

P-TO262-3-1: Outline

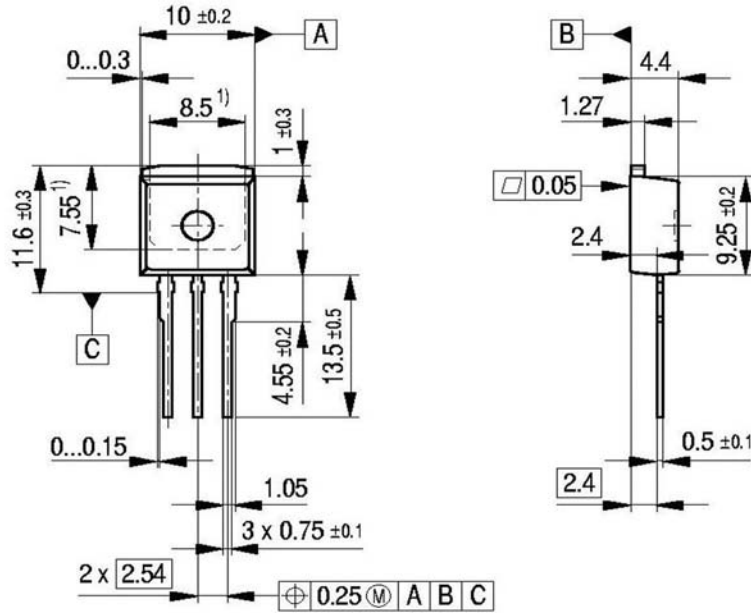

1) Typical
 Metal surface min. X = 7.25, Y = 6.9
 All metal surfaces tin plated, except area of cut.

P-TO220-3-1: Outline

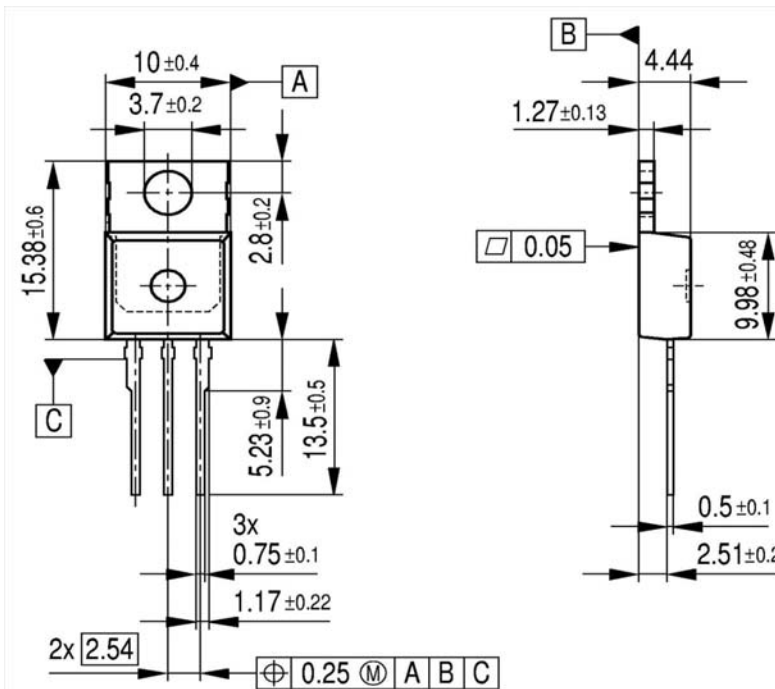

All metal surfaces tin plated, except area of cut.
 Metal surface min. x=7.25, y=12.3

Packaging

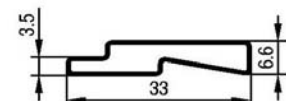

Dimensions in mm

Published by
Infineon Technologies AG
Bereich Kommunikation
St.-Martin-Straße 53
D-81541 München
© Infineon Technologies AG 1999
All Rights Reserved.

Attention please!

The information herein is given to describe certain components and shall not be considered as warranted characteristics.

Terms of delivery and rights to technical change reserved.

We hereby disclaim any and all warranties, including but not limited to warranties of non-infringement, regarding circuits, descriptions and charts started herein.

Infineon Technologies is an approved CECC manufacturer.

Information

For further information on technology, delivery terms and conditions and prices, please contact your nearest Infineon Technologies office in Germany or our Infineon Technologies representatives worldwide (see address list).

Warnings

Due to technical requirements, components may contain dangerous substances.
For information on the types in question, please contact your nearest Infineon Technologies office.

Infineon Technologies' components may only be used in life-support devices or systems with the expressed written approval of Infineon Technologies if a failure of such components can reasonably be expected to cause the failure of that life-support device or system, or to affect the safety or effectiveness of that device or system. Life support devices or systems are intended to be implanted in the human body, or to support and/or maintain and sustain and/or protect human life. If they fail, it is reasonable to assume that the health of the user or other persons may be endangered.